



B A C K Y A R D P L A N N I N G G U I D E

MICHAEL PHELPS SIGNATURE SWIM SPAS

by  MASTER SPAS®



MICHAEL PHELPS SIGNATURE SWIM SPAS

by  MASTER SPAS®

Step-by-Step Planning Guide



Whether you are considering purchasing a Michael Phelps Signature Swim Spa by Master Spas, or can't wait for yours to be delivered, this guide will provide you with important information about choosing a location and preparing for installation.



Choosing the Perfect Location

Every Master Spas Swim Spa is completely self-contained, making it quick and easy to install. All that's required is a solid, level surface that can handle the weight of the portable swim spa with water (around 20,000 lbs.*), GFCI electrical hook-up completed by a licensed electrician and a garden hose to fill it up. In less than a day, you will be enjoying the warm, swirling water of your own Master Spas Swim Spa.

Inside or Outside? Above Ground or Recessed? The Choice is Yours.

Master Spas Swim Spas are designed for inside or outside, year-round enjoyment and can be installed above ground, partially recessed or fully recessed. When choosing the location for your swim spa, consider how you will use your swim spa and what location will make it the most accessible and enjoyable for you and your family.

Location Planning Considerations

- How the swim spa will complement landscaping and vice versa
- The view from inside the swim spa and the view of the swim spa from inside the home
- Exposure to sunlight and shading from trees
- Privacy
- Getting to and from swim spa from the house
- Proximity to dressing rooms and bathrooms
- Storage for swim spa accessories and chemicals
- Local building codes (if applicable) and/or association requirements
- Access for routine maintenance or future repairs
- Power source

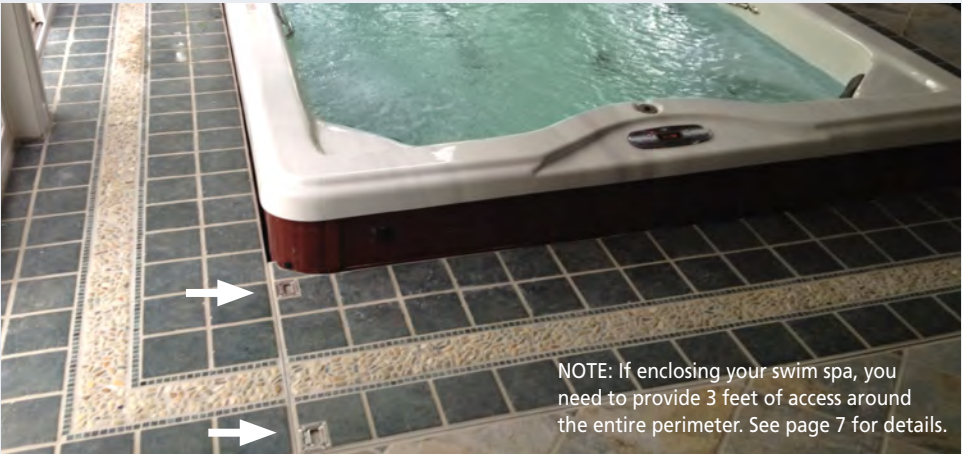

Inside Installation

Indoor installations are best when included as part of the construction process. This allows for the swim spa to be moved in prior to completion, making access to the space much simpler. Ventilation and humidity control is also important to consider with the design contractor.

For an indoor installation into an existing space, it is best to consult your dealer to determine the exact size of the opening needed to move the swim spa into the room, as this will vary based on the model you've selected.



Outside Installation

Every Master Spas Swim Spa is insulated with environmentally-friendly Icynene foam and the bottom is finished with a high-density polymer base, which helps keep heat in and unwanted pests out. These features coupled with our insulated covers makes Master Spa Swim Spas one of the most energy-efficient swim spas in the industry, year-round.



Above Ground

The majority of customers choose to install their swim spa fully above ground on a patio or deck. If wanting the look of a recessed installation without the expense, you may want to consider building a deck around the perimeter of the swim spa to give it a built-in look and feel.



NOTE: If enclosing your swim spa, you need to provide 3 feet of access around the entire perimeter. See page 7 for details.

Partially or Fully Recessed

It is possible to install your swim spa in a pit, either partially or fully recessed. In these types of installations it is important to ensure access to all sides of the swim spa. Additionally, proper drainage is essential. Because recessed installations have more extensive requirements, we recommend you discuss your plans with your dealer prior to completing the work to ensure there are no surprises down the road.

Installation Requirements

While Master Spa Swim Spas are relatively easy to install and have a short setup time, there are several requirements from foundation to equipment access to electrical specifications that must be met in order to ensure your new swim spa operates properly.

Foundation

When filled with water and people, a swim spa can weigh as much as several tons and it is imperative that the foundation beneath the swim spa be able to support this weight. The swim spa must be on a uniformly firm, continuous and level surface. The recommended foundation is a concrete pad with a minimum thickness of four (4) inches with steel reinforcement bars crossed throughout the pad.

Properly supported decks are acceptable, however, we advise against patio blocks, bricks, crushed stone, sand or stone dust as these foundations can shift seasonally. It is recommended that a proper structural engineering evaluation be done for any other type of installation.

If located outside, the area around your swim spa should drain well and slope away from the swim spa. Be sure to position your swim spa so that the equipment remains above grade and is not subject to flooding.

If you've selected an inside location or a partially or fully recessed installation it is imperative that a floor drain system be installed in the concrete pad. This system should be designed to move any water that may collect away from your swim spa.

Equipment Bay Access

Periodic maintenance checks require entry into the equipment bay and therefore easy access to this area is important. In addition, all sides of the swim spa must be accessible for future service. In the event that service is required, your dealer will need at least 3 feet of clearance around the perimeter of the swim spa. Whenever possible, it is wise planning to leave access to all sides of the swim spa as your swim spa warranty does not cover the cost of gaining access for service. This can be done by having removable panels in your deck or patio structure.

No Special Plumbing Required

One of the many great things about a Master Spas Swim Spa is that no special plumbing is required because it has a built in heater and filtration system. Simply fill the swim spa using a garden hose with filter* and drain it with an inexpensive submersible pump.



* This disposable sediment filter attaches to your garden hose and captures dirt particles in the water BEFORE they enter into your swim spa.

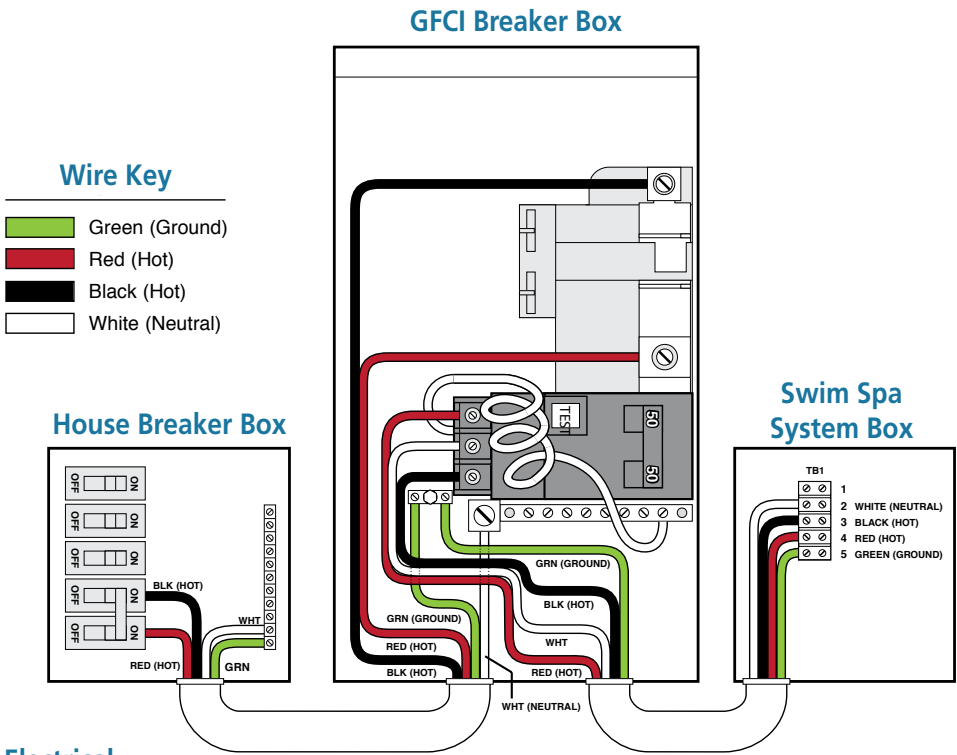

Electrical

Safety is absolutely the top priority at Master Spas. That's why every Master Spas Swim Spa is built and certified to stringent UL safety standards. UL is the most recognizable global independent company for safety testing. However, as with any other product that involves water, you should use common sense and follow all electrical precautions as outlined in your owner's manual.

All swim spas must be connected by a certified, licensed electrician. Depending on the swim spa chosen and the options selected, different levels of service may be needed. Your licensed electrician should follow these basic guidelines:

- Electrician should refer to the owner's manual before beginning any work. It outlines the power requirements, specifications and hook-up information for the specific model of swim spa purchased.
- All swim spas require a high-quality Ground Fault Circuit Interrupter (GFCI) circuit breaker. The GFCI is required by the National Electrician Code (NEC) for your protection.
- All electrical cables and wires must be routed through the swim spa cabinet. No wires or cables should be routed through the floor of the swim spa. Routing wires through the floor of the swim spa can result in damage to the structure or plumbing of the swim spa.
- All wire must be copper. Use of aluminum wire voids the swim spa warranty.

Ensuring a Smooth Delivery

The actual dimensions of your new swim spa will determine the amount of space that is needed for moving the swim spa from curbside to its final installation area. Check with your dealer to confirm the requirements based on the model you've selected. Walk the path that your new swim spa will travel during delivery and take measurements along the way. Be sure to measure side yard dimensions, gates or doors and vertical obstructions such as roof overhangs and overhead cables. Any other space limiting obstacles such as trees or shrubs must be evaluated as well.

Access to your chosen installation site must be solid, level ground that has been cleared of any obstructions prior to arrival. Keep in mind that you will need to remove any doors, windows, walls, handrails or other obstructions.

When your Master Spas Swim Spa arrives at your home, a forklift, crane or boom truck will most likely be needed to move the swim spa into position. If it is being installed indoors, it will need to be moved into place by sliding or rolling it.

Use the images below to help you determine the equipment and access needed based on the location you've selected for your swim spa. Be sure to consult your Master Spas dealer to determine the best and most cost effective delivery method for your swim spa.

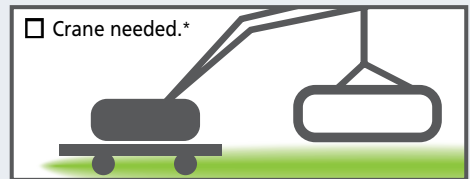
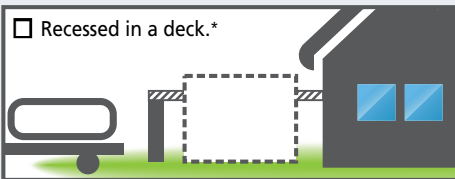
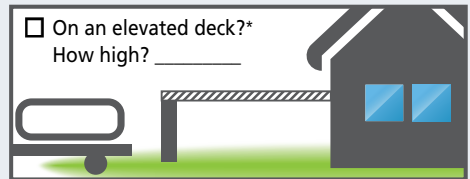
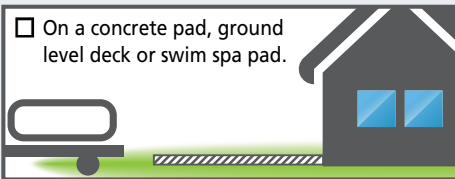

*Extra cost may apply.

Swim Spa Specifications

MICHAEL PHELPS SIGNATURE SWIM SPAS

Model	Dimensions	Electrical Requirements	Water Capacity	Dry Weight	Full Weight
MP Momentum D	231" x 94" x 60" (587 cm x 239 cm x 152 cm)	240V 80A & 240V 30A	2,325 gal (8,801 L)	3,700 lbs. (1,678 kg)	24,205 lbs. (10,979 kg)
MP Momentum	231" x 94" x 51" (587 cm x 239 cm x 130 cm)	240V 80A & 240V 30A	2,055 gal (7,779 L)	3,280 lbs. (1,488 kg)	21,530 lbs. (9,766 kg)
MP Signature	215" x 94" x 60" (546 cm x 239 cm x 152 cm)	240V 50A*	2,275 gal (8,612 L)	2,795 lbs. (1,268 kg)	22,510 lbs. (10,210 kg)
MP Signature S	215" x 94" x 60" (546 cm x 239 cm x 152 cm)	240V 50A*	2,265 gal (8,574 L)	3,060 lbs. (1,388 kg)	22,690 lbs. (10,292 kg)
MP Force D	201" x 94" x 60" (511 cm x 239 cm x 152 cm)	240V 50A	1,935 gal (7,325 L)	2,685 lbs. (1,218 kg)	19,565 lbs. (8,875 kg)
MP Force	201" x 94" x 51" (511 cm x 239 cm x 130 cm)	240V 50A	1,660 gal (6,284 L)	2,490 lbs. (1,129 kg)	17,075 lbs. (7,745 kg)
MP Impact	174" x 94" x 51" (442 cm x 239 cm x 130 cm)	240V 50A	1,525 gal (5,773 L)	2,245 lbs. (1,018 kg)	15,705 lbs. (7,124 kg)

* MP Signature and MP Signature S with Wave XP Pro option require two 240V, 50A services.



More Backyard Ideas

To see more installation photos with backyard ideas for your Michael Phelps Signature Swim Spa by Master Spas, download our free Master Spas Consumer App.

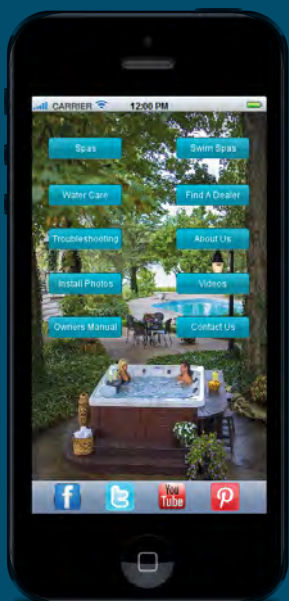

Master Spas Consumer App

- Master Spas Brochures
- Owners Manuals
- Water Care Guide
- Installation Photos
- Videos
- Troubleshooting Guide
- And much more!



Scan to
download

MICHAEL PHELPS SIGNATURE SWIM SPAS

by  MASTER SPAS®



OFFICIAL SUPPLIER



Manufactured by Master Spas, the world's largest swim spa manufacturer.

MasterSpas.com • MichaelPhelpsSwimSpa.com

Master Spas reserves the right to change specifications or features without notice. Master Spas is a manufacturer of swim spas and related products and we stand behind every product we produce pursuant to those representations which are stated in our written limited warranty. Your dealer is an independent business person or company and not an employee or agent of Master Spas, Inc. We cannot and do not accept any responsibility or liability for any other representations, statements or contracts made by any dealer beyond the provisions of our written limited warranty.

REMINDER: Never allow anyone to dive into a swim spa. Always enter feet first.



LITMP07-2015 © 2015 Master Spas, Inc.
260 436 9100 sales@masterspas.com